

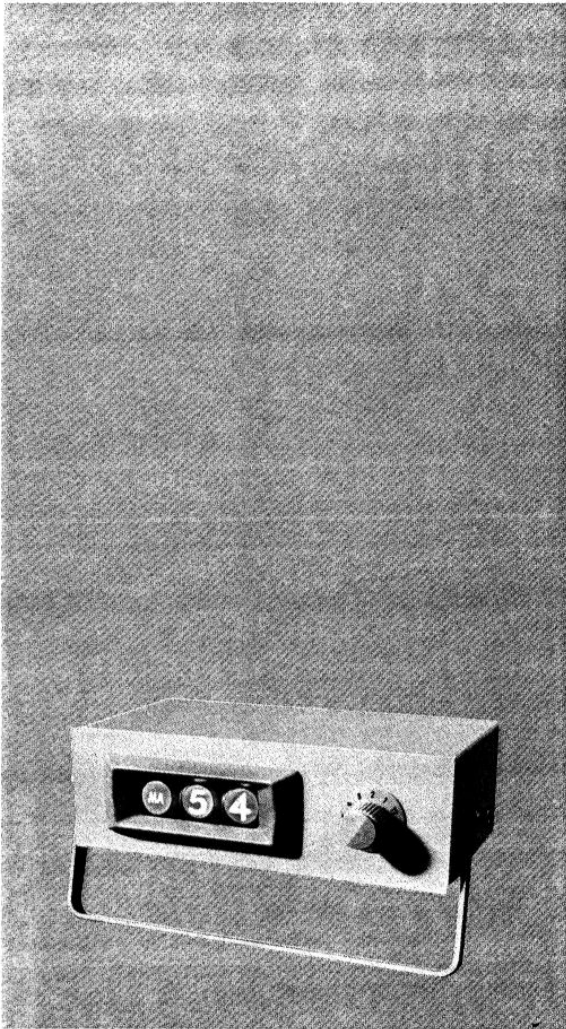

An industry first from **IEE** A single-plane Vacuum Tube Readout • Digital displays, unsurpassed in brightness and clarity • Projected onto a fluorescent screen from a 10 Gun CRT • Easily viewed under direct sunlight • Ideal under any ambient light conditions • Powerless control grid switching • Extremely low power consumption (*Approx. 300 Milliwatts*) • Small grid control swing • Exceptionally wide viewing angle • Continuous brightness control under simple external circuitry (*up to 500 FL*) • No external focusing means required • The ultimate for your readout application.



APPLICATION

The IEE Vacuum Tube Readouts have extensive applications, from Elevators through Electronic Instrumentation, in addition to sophisticated systems and Missile Count Down Display requirements. Designed, produced and manufactured under optimum conditions its operational performance is one of utmost versatility and dependability.

Typical applications include:

- Digital Voltmeters
- Digital Clocks
- Frequency Counters
- Computer Console Readouts
- Aircraft Displays
- Indicators
- Oscilloscopes
- Tachometers
- Flight Simulators
- Medical Electronic Devices
- Teaching Machines
- Stock Quotation Displays
- Flowmeters

ELECTRICAL CHARACTERISTICS

Filament voltage, AC or DC	1.1V ± .15V
Filament current	0.2 A
Anode voltage (Normal)	2.5KVDC
Anode current (Normal)	35 microamps
Normal brightness	110 FTL
<small>(For other than normal intensities refer to brightness vs. Anode voltage curve.)</small>	
Grid voltage (Cut-Off)	-6.0VDC
Except selected grid to display (Full "On")	+4.0VDC

NOTE

Negative grid voltage in excess of 20V not recommended. If operated from low resistance grid circuits (under 1 megohm), careful check for excessive anode current is required since positive grid voltages drawing more than a few microamps of grid current may result in driving the tube into excessive plate current regions, causing permanent screen damage. Susceptibility to magnetic interference is relatively small. Avoid operation in strong AC or DC fields.*

*Tubes will not be replaced as a result of burned phosphor.

Phosphor (Standard)	P31 (RCA)
<small>For other types consult IEE</small>	

Fluorescence	Green
Persistence	Medium

DISPLAY CHARACTERISTICS

(For Standard Model)

Maximum No. of Characters	10 (0-9)
Character Height	5/8 inch
Character Style	Futura Medium
<small>For others, including symbols, consult IEE.</small>	

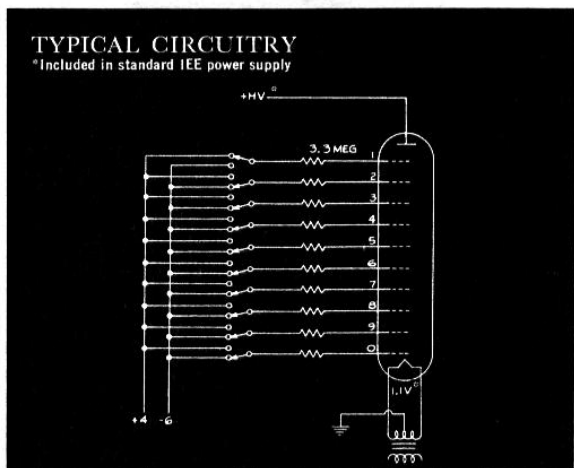
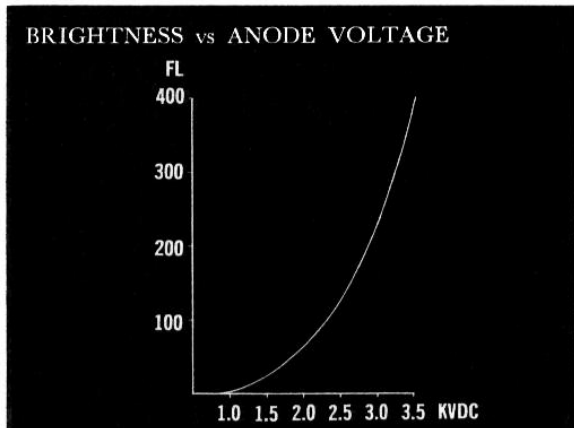

BASING DIAGRAM

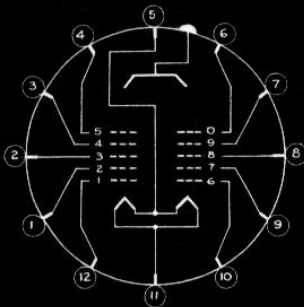

TERMINAL CONNECTION

Pin 1.....Number 2	Pin 7.....Number 9
Pin 2.....Number 3	Pin 8.....Number 8
Pin 3.....Number 4	Pin 9.....Number 7
Pin 4.....Number 5	Pin 10.....Number 6
Pin 5.....Filament	Pin 11.....Filament
Pin 6.....Number 0	Pin 12.....Number 1

ENVIRONMENTAL CHARACTERISTICS

(Results of preliminary tests)

Vibration 10-50-10 cps at .06" D.A. x1, x2 & x3 axis.
Shock 100G's, 11 Millisec.
RFI MIL-I-26600
Life Estimated to be 10,000 hours at 100 FL (testing incomplete)

POWER SUPPLY

IEE has standard power supplies available which supply all filament and anode voltage.

Specifications are:

Input Voltage 115VAC @ .025 A.
Other Input Voltages	available upon request. Standard P/S Designed for Max. of 10 Tubes.

*Either fixed for normal brightness or variable.

MOUNTING HARDWARE

Standard mounting hardware for assemblies of 1-10 units is available from IEE; and all parts required for a given assembly are available in kit form.

MECHANICAL CHARACTERISTICS

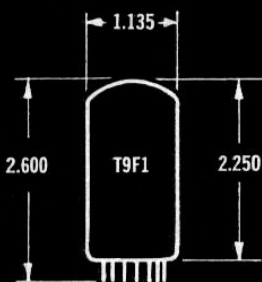

Operating position Any
Envelope T9 F 1 Special Top, Glass
Base 12 Pin
Anode connection Side Button
Socket Cinch-Jones, 12 CS-B
Max. outside diameter 1.135"
Max. overall length 2.60"
Seated height 2.25 ± 0.32"

ORDERING INFORMATION

1. Tube Type	_____	B A	0000 - P31
2. Character Display No.	0000 (0-9)		
3. Phosphor Color = Standard (P31)			
			Optional (P1), (P7), (P12), (P20)

PRICING INFORMATION

The following pricing is for the Standard IEE Vacuum Tube Readout Model #BA-0000-P31. The standard model projects the digits 0 thru 9 which are green in color and 5/8" high. Other color options are available at no extra cost. Contact the factory for other standard character sets. If a new character mask is desired, a set-up charge is required on your first order.

VACUUM TUBE		POWER SUPPLY (Consists of filament transformer and variable power supply.) Please note: Each power supply is capable of driving up to 10 vacuum tube readouts.	
Qty.	Price Per Tube	Qty.	Price Per Power Supply
1-9	\$20.00	1-9	\$18.00
10-24	18.50	10-24	16.00
25-49	17.50	25-49	14.50
50-99	16.50	50-99	13.50
100-249	15.75	100-249	13.25
250-499	15.00	250-499	13.00
500-999	14.50	500-999	12.75
1000-Over	14.00	1000-Over	12.50

TUBE MOUNTING HARDWARE (Consists of mounting hardware and socket)		BEZEL ASSEMBLY	
Qty.	Price Per Readout	Size	Price
1 and Over	\$2.00	1 to 4 units	\$ 5.00
		5 to 8 units	\$ 7.50
		9 or 10 units	\$10.00

QUANTITY DISCOUNTS ON EXTENDED SHIPMENTS

- To break an order down into more than one shipment, the order must total 100 or more display units.
- Each shipment must equal at least 10% of total order or 25 units (whichever is larger).
- Shipments on a particular order must be completed within 12 months from receipt of order.
- Quantity orders cancelled before completion will be billed at prices based on the price schedule for the number of displays actually shipped.

TERMS AND CONDITIONS

- MINIMUM BILLING - \$5.00.
- F.O.B. - All prices F.O.B. our plant, Van Nuys, California.
- TERMS - 1/2 of 1% 10 days; net 30 days.
- DELIVERY - For standard displays, 60 days depending upon quantity.
- RETURN OF GOODS - Positively no products may be returned without factory authorization. All claims must be made within 10 days after receipt of goods.
- All prices subject to change without notice.

ASSEMBLY AND INSTALLATION KIT

Patents are applied for on this tube in the United States and foreign countries. Sale of this tube grants a license for use for any purpose, but does not convey any license under patent claims on combinations of this tube with other devices or elements.

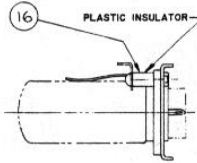
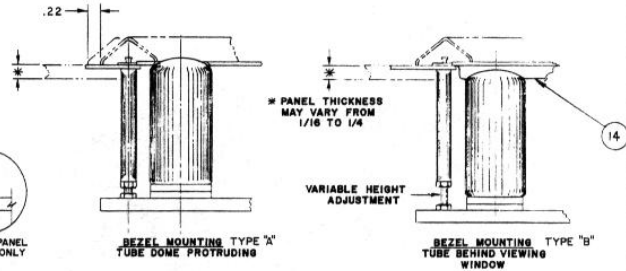
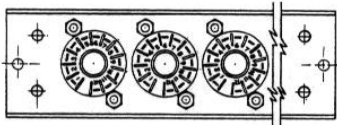
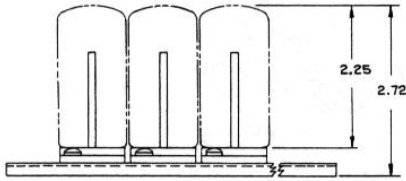
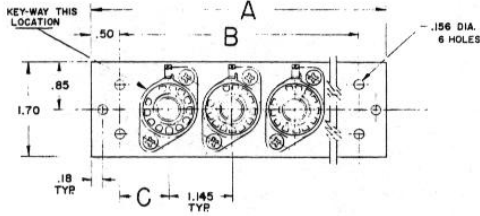

ORDERING INFORMATION

HOW TO ORDER COMPLETE KIT (LESS TUBE)
(FOR TUBE INFORMATION SEE I.E.E. CATALOG SHEET)

COMPLETE SET OF MOUNTING HARDWARE FOR NUMBER OF UNITS:

1 K	5 K
2 K	7 K
3 K	8 K
4 K	9 K
5 K	10 K

FOR MORE THAN 10 UNITS, CONSULT I.E.E.

FRONT COVER: TYPE "A" TUBE DOME PROTRUDING
TYPE "B" TUBE BEHIND VIEWING WINDOW

BEZEL ASSEMBLY SIMILAR TO THE FOLLOWING
COLOR CODE: FEDERAL NO. 959 COLOR NOS.

01 SLATE HC	26231
02 BLACK HC	26044
03 SMOKE GREY HC	26280
04 LIGHT GREY HC	26357
05 SAND HC	26890
06 WHITE HC	27878

WHEN BEZEL ASSEMBLY IS ORDERED BY MOUNTING CONFIGURATION, AND COLOR CODE, e.g., TYPE "B"-03, THIS INCLUDES THE FOLLOWING ITEMS:

NO. OF PCS.	DESCRIPTION
1	BEZEL ASSEMBLY, SMOKE GREY HC
2	ITEM NO. 6
2	ITEM NO. 7
1	ITEM NO. 47 IF TYPE "A" IS ORDERED, ITEM NO. 14 IF TYPE "B" IS ORDERED

(ADDITIONAL COLORS AVAILABLE, CONSULT I.E.E.)

POWER SUPPLY--50 STANDARD 117 VAC INPUT (SPECIFY FIXED OR VARIABLE ANODE VOLTAGE)

(OTHER VOLTAGES OPTIONAL UPON REQUEST)

▲ FOR SPARE PARTS PROCUREMENT, SPECIFY NUMBER OF UNITS & TYPE OF MTG.
▲ LENGTH OF ITEM 12, 1/2" FOR TYPE "A", 3/4" FOR TYPE "B".
▲ LIST OF MAT'L. FOR SPARE PARTS PROCUREMENT ONLY.

TO BE USED WHEN ORDERING TUBE MTG. & SCKT ASS'Y KIT

UNIT NO.	±.02	±.010	2.010	±.010	±.010	STANDARD PART NO. SEE ORDERING INFORMATION
	A	B	C	D	E	
1	2.86	1.86	.930	1.46	1.86	1K-B-01-50
2	3.93	2.93	.892	2.53	2.93	2K-B-01-50
3	5.19	4.19	.948	3.79	4.19	3K-B-01-50
4	6.33	5.33	.948	4.93	5.33	4K-B-01-50
5	7.67	6.67	1.046	6.27	6.67	5K-B-01-50
6	8.67	7.67	.971	7.27	7.67	6K-B-01-50
7	9.66	8.66	.896	8.26	8.66	7K-B-01-50
8	10.91	9.91	.948	9.51	9.91	8K-B-01-50
9	12.47	11.47	1.156	11.07	11.47	9K-B-01-50
10	13.54	12.54	1.118	12.14	12.54	10K-B-01-50

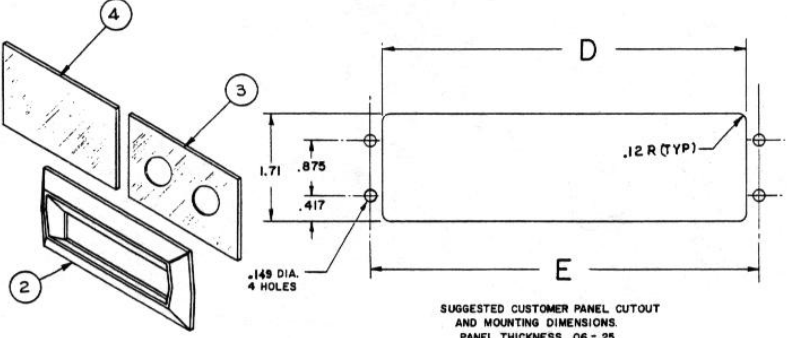

SUGGESTED CUSTOMER PANEL CUTOUT AND MOUNTING DIMENSIONS. PANEL THICKNESS .06-.25

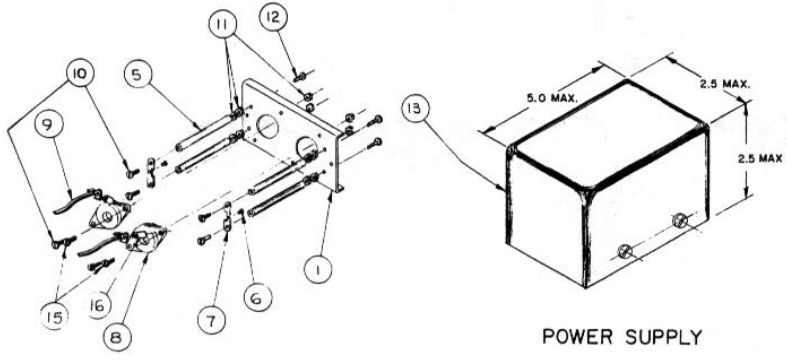

POWER SUPPLY

AR	AR	16	80002	STAND OFF, INSUL.
AR	AR	15	6-32x 3/4-LG	SCREW, NYLON, R.H.
I	I	14	80000	LINER
I	I	13	14549	POWER SUPPLY
4	4	12	6-32 x 1/2 LG	SCREW, RD. HD.
AR	AR	11	6-32	NUT, HEX
AR	AR	10	6-32x 1/2 LG.	SCREW RD. HD.
AR	AR	9	14476	CONTACT, H.V
AR	AR	8	1125-B, OR 1125-10-10-048	SOCKET, TUBE
2	2	7	13238	PLATE, BUTTON
2	2	6	13432-1	BUTTON, BEZEL
4	4	5	14486	STAND OFF
I	I	4	14547	FRONT COVER, PLAIN
I	I	3	14548	FRONT COVER, DOME
I	I	2	13197	BEZEL
I	I	1	14479	MOUNTING BRACKET

TYPE	TYPE "A"	ITEM NO.	PART NO.	NAME	MATERIAL	DESCRIPTION
MTG	MTG					

This is a preliminary design specification sheet. All design details are subject to change without notice.

IEE Industrial Electronic Engineers, Inc.

7720 Lemona Avenue, Van Nuys, California 91405
Phone: (213) 787-0811 TWX (910) 495-1707